

# Identification and Convergence Analysis of a Class of Continuous-Time Multiple-Model Adaptive Estimators<sup>\*</sup>

A. Pedro Aguiar,<sup>\*</sup> Vahid Hassani,<sup>\*</sup> António M. Pascoal,<sup>\*</sup>  
Michael Athans<sup>\*,\*\*</sup>

*<sup>\*</sup> Institute for Systems and Robotics (ISR),  
Instituto Superior Técnico (IST), Lisbon, Portugal  
e-mail: {pedro,vahid,antonio,athans}@isr.ist.utl.pt  
Tel: (+351) 21 841 8054, Fax: (+351) 21 841 8291*

*\*\* Michael Athans is also Professor of EECS (emeritus), M.I.T., USA.*

---

**Abstract:** This paper discusses the identification and convergence, in a deterministic setting, of a class of Continuous-Time Multiple-Model Adaptive Estimators (CT-MMAE) for state-affine multiple-input-multiple-output systems with parametric uncertainty. The CT-MMAE is composed by a dynamic weighting signal generator and a bank of local continuous-time observers where each observer is designed using one element of a finite discrete model (parameter) set. The state estimate is generated by a weighted sum of the estimates produced by the bank of observers and the parameter estimate is selected to be the one that corresponds to the weighted signal with the largest value. We show that under suitable persistent of excitation like conditions the model identified is the one that exhibits less output error “power”. Furthermore, a distance-like metric between the true plant and the identified model is derived. We also provide conditions for convergence of the state estimation error and for  $\mathcal{L}_2$  and  $\mathcal{L}_\infty$  input-to-state stability. These deterministic continuous time results complement existing knowledge for stochastic discrete-time MMAE designs.

Keywords: Multiple-Model Adaptive Estimation; Observers, Stability; Convergence.

---

## 1. INTRODUCTION

The design of a single state-estimator for a plant requires exact knowledge of the plant parameters for optimal performance. In practice, parameter uncertainty and/or parameter variations will impact the robustness of the estimator. In fact, incorrect modeling in the estimator may lead to large estimation errors or even divergence (see Price [1986], Fitzgerald [1971]). To cope with this problem, adaptive estimators (where the adaptation is with respect to the uncertainty in the plant parameters) have been proposed.

Many approaches to the problem of adaptive estimation have been considered in the literature. In particular, the Multiple Model Adaptive Estimation (MMAE) algorithm has received considerable attention.

The use of multiple models for Adaptive Estimation is by no means new. In the 1960s and 1970s several authors including Magill [1965], Lainiotis [1976], Athans et al. [1977; 1979], Anderson and Moore [1979], and Li and Bar-Shalom [1996] studied Kalman filter based models and LQG controllers as a basis for adaptive control.

In MMAE a separate discrete-time Kalman filter (KF) is developed for each different assumed value of the uncertain

parameters defining a “model”. The resulting set of KFs forms a “bank” where each local KF generates its own state estimate and an output error (residual) as shown in Fig. 1. The bank of KFs runs in parallel and at each time the residuals are used to compute for each KF the conditional probability that it corresponds to the correct parameter value. The overall state estimate is a weighted combination of each filter’s estimate. The rationale is that the highest probability should be assigned to the most accurate KF, and lower probabilities assigned to the other KFs. Since the range of parametric uncertainty is continuous, the uncertain parameters can take on an infinite number of different values. In practice, the parameter space must be discretized to keep the number of filters realizable. The discretized parameter space is composed of representative point values that define the elemental Kalman filters. Intuitively, one can say that more models have to be used to improve the accuracy but this in turn increases the computational burden. In fact, the number of local observers needed and how to quantize the parameter space optimally are still open issues.

The stochastic continuous-time MMAE (CT-MMAE) was introduced in Dunn and Rhodes [1973] and Dunn [1974] but no further research has been carried out on this subject, to the best of our knowledge (except Aguiar et al. [2007a]). In this case, the plant in Fig. 1 is described by a stochastic differential equation,  $w$  and  $v$  are continuous-time white noises, and the estimators are continuous-time steady state KFs. The dynamic weights are generated by

---

<sup>\*</sup> Research supported in part by project DENO / FCT-PT (PTDC/EEA-ACR/67020/2006) and by the FCT-ISR/IST pluri-annual funding program through the POS\_C Program that includes FEDER funds.

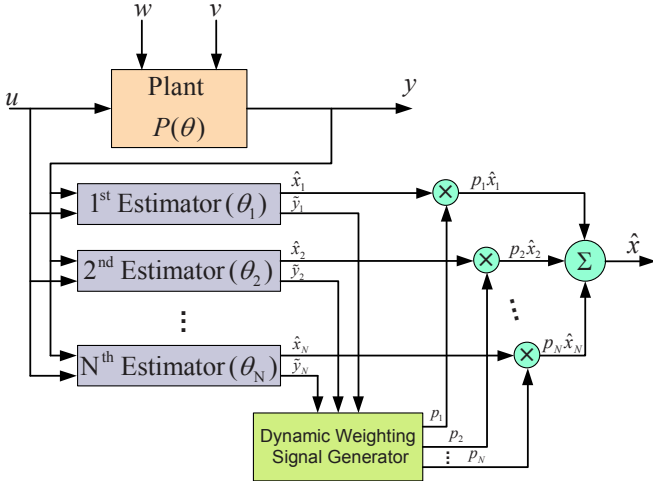

Fig. 1. The MMAE architecture.

a continuous time differential equation. No convergence results were derived in Dunn and Rhodes [1973], Dunn [1974].

We now present the main motivation behind this research. Although MMAEs are important in their own right (for navigation, tracking, surveillance, etc.) they have also formed the basis for Multiple-Model Adaptive Control (MMAC). Some of the MMAC approaches use continuous-time deterministic architectures; Anderson et al. [2000], Hespanha et al. [2001], Morse [1996; 1997], Narendra and Balakrishnan [1997], Narendra and Driollet [2001]. On the other hand, many MMAC approaches use discrete-time stochastic frameworks; Athans et al. [1977], Schiller and Maybeck [1997], Morse [1996], Athans et al. [2005], Fekri et al. [2006; 2007]. As pointed out in the later references, there is a need to understand the connection between the discrete-time stochastic MMAC designs and the deterministic continuous-time ones. The results in this paper should be useful along this direction and the convergence of the deterministic MMAE to its nearest model is of great importance. This is the main contribution of this paper.

Following the work of Krener [1980] one can interpret continuous-time Kalman filters as deterministic observers and view, and analyze, the CT-MMAE architecture in Fig. 1 in a deterministic setting, where the plant is described by a linear continuous time-varying system and the estimators are Krener observers (KOs). We propose a Dynamic Weighting Signal Generator (DWSG) system (different from the one considered in Aguiar et al. [2007a]) that guarantees the following properties: *i*) the weights  $p_i$  are always positive and bounded above by 1; *ii*) under suitable persistency of excitation conditions, one of them converges to 1 and the others converge to zero. We show that the model identified is the one that exhibits less output error “power”. A distance-like metric between the true plant and the identified model is derived. We also provide conditions for convergence of the state estimation error and for  $\mathcal{L}_2$  and  $\mathcal{L}_\infty$  input to state stability.

The structure of the paper is as follows. In section 2 we review the main issues of CT-MMAE and we define the details of the CT-MMAE of Fig. 1. Section 3 summarizes our main results and Section 4 contains the proofs. Section 5 illustrates the performance of the CT-MMAE algorithm

proposed through computer simulations. Conclusions and suggestions for future research are summarized in Section 6. Due to space limitations, some proofs are omitted. These can be found in Aguiar et al. [2007b].

**Notation and definitions:** We denote by  $x \in \mathbb{R}^n$  a vector and by  $P$  a symmetric, positive definite  $n \times n$  matrix.  $\|x\|$  denotes the standard Euclidean norm of vector  $x$  and  $\|x\|_P := (x'Px)^{1/2}$ . A piecewise continuous function  $\phi : [0, T) \rightarrow \mathbb{R}^n$ ,  $T \in (0, \infty]$  is in  $\mathcal{L}_2$  if  $\int_0^T \|\phi(\tau)\|^2 d\tau < c$  for some constant  $c$ . The RMS norm<sup>1</sup> of a deterministic vector signal  $u$  is defined as  $\|u\|_{rms} := \left( \lim_{T \rightarrow \infty} \frac{1}{T} \int_0^T u(t)'u(t) dt \right)^{1/2}$  provided that this limit exists. The RMS can be expressed in terms of the autocorrelation of  $u$ ,  $R_u(\tau) := \lim_{T \rightarrow \infty} \frac{1}{T} \int_0^T u(t)'u(t + \tau) dt$ , or its power spectral density,  $S_u(\omega) := \int_{-\infty}^{\infty} R_u(\tau)e^{-j\omega\tau} d\tau$ , as follows:  $\|u\|_{rms}^2 = R_u(0) = \frac{1}{2\pi} \int_{-\infty}^{\infty} S_u(\omega) d\omega$ .

## 2. THE MULTIPLE-MODEL ADAPTIVE ESTIMATOR

In this section we propose a class of CT-MMAE modeled in a purely deterministic setting. We consider state-affine multiple-input-multiple-output (MIMO) systems of the form

$$\dot{x}(t) = A(t, \theta)x(t) + B(t, \theta)u(t) + G(t)w(t), \quad (1a)$$

$$y(t) = C(t, \theta)x(t) + v(t), \quad (1b)$$

where  $x(t) \in \mathbb{R}^n$  denotes the state of the system,  $u(t) \in \mathbb{R}^m$  its control input,  $y(t) \in \mathbb{R}^q$  its measured noisy output,  $w(t) \in \mathbb{R}^r$  an input plant disturbance that cannot be measured, and  $v(t) \in \mathbb{R}^p$  measurement noise. The matrices  $A(t, \theta)$ ,  $B(t, \theta)$ , and  $C(t, \theta)$  are assumed piecewise continuous, uniformly bounded in time, and contain *unknown constant parameters* denoted by vector  $\theta \in \mathbb{R}^l$ . The initial condition  $x(0)$  of (1a) and the signals  $w$  and  $v$  are assumed deterministic but unknown.

Consider a finite set of candidate parameter values  $\Theta := \{\theta_1, \theta_2, \dots, \theta_N\}$  indexed by  $i \in \{1, \dots, N\}$ . We propose the following CT-MMAE:

$$\hat{x}(t) := \sum_{i=1}^N p_i(t)\hat{x}_i(t), \quad (2)$$

$$\hat{\theta}(t) := \theta_{i^*}, \quad i^* := \arg \max_{i \in \{1, \dots, N\}} p_i(t), \quad (3)$$

where  $\hat{x}(t)$  and  $\hat{\theta}(t)$  are the estimates of the state  $x$  and parameter vector  $\theta$  at time  $t$ , respectively, and  $p_i$ ;  $i = 1, \dots, N$  are dynamic weights defined later. In (2), each  $\hat{x}_i$ ;  $i = 1, \dots, N$  corresponds to a “local” state estimate generated by a (deterministic) Kalman-Bucy filter or min-max filter (Krener [1980]) of the type<sup>2</sup>

$$\dot{P}_i = A_i P_i + P_i A_i' + G Q G' - P_i C_i' R^{-1} C_i P_i, \quad (4a)$$

$$\dot{\hat{x}}_i = A_i \hat{x}_i + B_i u + P_i C_i' R^{-1} (y - C_i \hat{x}_i), \quad (4b)$$

where  $A_i(t) := A(t, \theta_i)$  (the same notation applies to  $B_i$  and  $C_i$ ) and  $P_i(0) = P_{0i}$ ,  $\hat{x}_i(0) = \hat{x}_{0i}$ . The matrices  $P_{0i}$ ,  $Q(t)$  and  $R(t)$  play the same role as the covariances and white-noise intensities of the corresponding Kalman-Bucy filter models.

<sup>1</sup> In fact, this is not a norm but a semi-norm.

<sup>2</sup> For simplicity of notation, we will drop the arguments of the matrices.

In the structure proposed, the dynamic weights  $p_i \in \mathbb{R}$ ,  $i = 1, \dots, N$  in (2),(3) satisfy

$$\dot{p}_i = -\lambda \left( 1 - \frac{\beta_i e^{-\omega_i}}{\sum_{j=1}^N p_j \beta_j e^{-\omega_j}} \right) p_i, \quad p_i(0) = p_{0i} \quad (5)$$

where  $\lambda$  is a positive constant,  $\beta_i(t)$  is a signal assumed to satisfy the condition  $c_1 \leq \beta_i(t) \leq c_2$  for some positive constants  $c_1, c_2$  and  $\omega_i(\cdot)$  is a continuous function called an *error measuring function* that maps the measurable signals of the plant and the states of the  $i$ -th local estimator to a nonnegative real value. Examples of an error measuring function and a  $\beta_i$  function are  $\omega_i := \frac{1}{2} \|\hat{y}_i - y\|_{S_i}^2$  and  $\beta_i := \frac{1}{\sqrt{\det S_i}}$ , respectively, where  $S_i$  is a positive definite weighted matrix.

The structure of the key equation (5), which generates the time-evolution of the weights  $p_i$ , was inspired by the continuous approximation of the “standard” discrete MMAE formulas (see Anderson and Moore [1979]).

We impose the constraint that the initial conditions  $p_{0i}$  be chosen such that  $p_{0i} \in (0, 1)$  and  $\sum_{i=1}^N p_{0i} = 1$ . The parameters  $G, Q, R, \lambda$  and the functions  $\beta_i, \omega_i$  are tuning parameters/functions of the CT-MMAE chosen by the designer.

### 3. MAIN RESULTS

In this section we summarize our main results regarding the CT-MMAE. We first show that positiveness and boundedness of the dynamic weights  $p_i(t)$  are independent of the input signals of the dynamic weighting signal generator (DWSG) system. We also show that the overall sum of the  $p_i$ 's is always unity for all  $t \geq 0$ .

*Theorem 1.* Suppose that  $p_{0i} \in (0, 1)$  and  $\sum_{i=1}^N p_{0i} = 1$ . Then, each  $p_i(t)$ ,  $i = 1, \dots, N$  governed by (5) is nonnegative, uniformly bounded and contained in the interval  $[0, 1]$  for every  $t \geq 0$ . Furthermore,

$$\sum_{i=1}^N p_i(t) = 1, \quad \forall t \geq 0$$

□

We next provide conditions for the convergence of the dynamic weights  $p_i(t)$ .

*Theorem 2.* Let  $i^* \in \{1, 2, \dots, N\}$  be an index of a parameter vector in  $\Theta$  and  $\mathcal{I}_* := \{1, 2, \dots, N\} \setminus i^*$  an index set. Suppose that there exist positive constants  $T, c$ , and  $\epsilon$  with  $\epsilon > c$  such that for all  $t \geq 0$  the following condition holds

$$\frac{1}{T} \int_t^{t+T} (\omega_{i^*}(\tau) + \epsilon) d\tau < \frac{1}{T} \int_t^{t+T} \min_{j \in \mathcal{I}_*} \omega_j(\tau) d\tau \quad (6)$$

and  $\sup_{t \geq 0} \ln \frac{\max_{j \in \mathcal{I}_*} \beta_j}{\beta_{i^*}} \leq c$ . Then,  $p_{i^*}(t)$  governed by (5) satisfies  $p_{i^*}(t) \rightarrow 1$  as  $t \rightarrow \infty$ .

□

To get some intuition for the meaning of (6), note that if the error measuring functions  $\omega_i(\cdot)$ ,  $i \in \{1, \dots, N\}$  are uniformly persistently exciting (PE), i.e., there exist positive constants  $\mu_i$  and  $T$  such that for every  $t \geq 0$

$$\frac{1}{T} \int_t^{t+T} \omega_i(\tau) d\tau \geq \mu_i,$$

condition (6) is equivalent to

$$\mu_{i^*} + \epsilon < \frac{1}{T} \int_t^{t+T} \min_{j \in \mathcal{I}_*} \omega_j(\tau) d\tau.$$

Thus, roughly speaking, the “model” identified is the one that exhibits less measuring error “power”. More precisely, we obtain the following Corollary.

*Corollary 3.* Suppose that condition (6) of Theorem 2 holds for some  $i = i^* \in \{1, \dots, N\}$ . Then, the parameter estimate  $\hat{\theta}(t)$  converges to the closest to the true parameter  $\theta$  in the following sense

$$\lim_{t \rightarrow \infty} \hat{\theta} = \theta_{i^*}, \quad i^* = \arg \min_{i \in \{1, \dots, N\}} \lim_{T \rightarrow \infty} \frac{1}{T} \int_0^T \omega_i(\tau) d\tau$$

□

For Linear Time-Invariant (LTI) systems and selecting weighted quadratic norms of the output estimation errors for the error measuring functions we obtain the following result.

*Corollary 4.* Let  $\omega_i := \|\hat{y}_i - y\|_{S_i}^2$  with  $S_i > 0$  and suppose that the conditions of Theorem 2 hold. If  $w, v, u$  are bounded-spectral signals with spectral factor  $S_{in} = W(j\omega)^* W(j\omega)$ , then the parameter estimate  $\hat{\theta}(t)$  converges to the closest to the true parameter  $\theta$  in the following sense

$$\lim_{t \rightarrow \infty} \hat{\theta} = \theta_{i^*}, \quad (7a)$$

$$i^* = \arg \min_{i \in \{1, \dots, N\}} \|S_i^{1/2} (C_i(sI - A_i)^{-1} B_i + D) W(s) S_i^{-1/2}\|_2 \quad (7b)$$

where

$$\begin{aligned} A_i &:= \begin{bmatrix} A & 0 \\ L_i C & A_i - L_i C_i \end{bmatrix}, & B_i &:= \begin{bmatrix} G & 0 & B \\ 0 & L_i & B_i \end{bmatrix}, \\ C_i &:= [-C \ C_i], & D &:= [0 \ -I \ 0]. \end{aligned}$$

□

The above Corollary leads to an algorithm to compute the sets  $\Omega_i$  consisting, for each  $i$ , of the set of actual parameters  $\theta \in \mathbb{R}^l$  for which the corresponding parameter estimated is  $\theta_i$ . With a certain abuse of notation, we will refer to  $\Omega_i$  as the regions of attraction of  $\theta_i$ .

The following result establishes the convergence of the state estimate  $\hat{x}(t)$ .

*Theorem 5.* Suppose that (1) is asymptotically stable and that there exist positive constants  $\delta_1, \delta_2 \in (0, \infty)$  such that

$$\delta_1 I \leq G(t) Q(t) G(t)' \leq \delta_2 I. \quad (8)$$

Then, if  $P$  remains uniformly bounded and condition (6) holds for some  $i = i^* \in \{1, \dots, N\}$ , the state estimation error  $\tilde{x}(t) := \hat{x}(t) - x(t)$  satisfies the following properties:

$\mathcal{L}_\infty$  to  $\mathcal{L}_\infty$

$$\begin{aligned} \|\tilde{x}(t)\| &\leq c e^{-\lambda t} \|\tilde{x}(0)\| + \gamma_w \sup_{\tau \in [0, t]} \|w(\tau)\| \\ &\quad + \gamma_v \sup_{\tau \in [0, t]} \|v(\tau)\| + \gamma_u \sup_{\tau \in [0, t]} \|u(\tau)\| \end{aligned} \quad (9)$$

$\mathcal{L}_2$  to  $\mathcal{L}_\infty$

$$\begin{aligned} \|\tilde{x}(t)\| &\leq c e^{-\lambda t} \|\tilde{x}(0)\| + \gamma_w \int_0^t \|w(\tau)\|^2 d\tau \\ &\quad + \gamma_v \int_0^t \|v(\tau)\|^2 d\tau + \gamma_u \int_0^t \|u(\tau)\|^2 d\tau \end{aligned} \quad (10)$$

$\mathcal{L}_2$  to  $\mathcal{L}_2$

$$\begin{aligned} \int_0^t \|\tilde{x}(t)\|^2 d\tau &\leq c\|\tilde{x}(0)\| + \gamma_w \int_0^t \|w(\tau)\|^2 d\tau \\ &\quad + \gamma_v \int_0^t \|v(\tau)\|^2 d\tau + \gamma_u \int_0^t \|u(\tau)\|^2 d\tau \end{aligned} \quad (11)$$

□

From Theorem 5 it follows that the state estimate  $\hat{x}$  converges exponentially fast to the true state  $x$  in the absence of disturbance input  $\omega$ , measurement noise  $\nu$ , and input signal  $u$ . However, when this is not the case,  $\hat{x}$  converges to a neighborhood of the true state  $x$ . The size of this neighborhood depends not only on the size of the noise and disturbance (as expected) but also on the input signal  $u$ . Furthermore, close examination of the proof of the Theorem shows that the size of the neighborhood depends also on the mismatch between the parameter used to derive the local estimator and the real parameter.

The next Theorem gives conditions under which the above dependence on  $u$  ceases to exist asymptotically, as  $t \rightarrow \infty$ .

*Theorem 6.* Let  $\hat{x}_\theta, P_\theta$  be the state variables of the min-max filter (4) designed for the true parameter  $\theta$  and  $\omega_\theta$  the corresponding error measuring function. Suppose that  $\theta$  belongs to the discrete set  $\Theta$  and let  $i_\theta$  be the corresponding index. If the following identifiability condition holds

$$\lim_{T \rightarrow \infty} \frac{1}{T} \int_0^T (\omega_\theta(\tau) + \epsilon) d\tau < \lim_{T \rightarrow \infty} \frac{1}{T} \int_0^T \omega_i(\tau) d\tau \quad (12)$$

for all  $i \in \mathcal{I}_\theta := \{1, \dots, N\} \setminus i_\theta$  and for some  $\epsilon > \max\{0, \sup_{t \geq 0} (\ln \max_{j \in \mathcal{I}_\theta} \beta_j - \ln \beta_{i_\theta})\}$ , then

$$\lim_{t \rightarrow \infty} \hat{\theta}(t) = \theta, \quad (13)$$

$$\lim_{t \rightarrow \infty} \sup \| \tilde{x}(t) \| \leq \gamma_w \lim_{t \rightarrow \infty} \sup \| w(t) \| + \gamma_v \lim_{t \rightarrow \infty} \sup \| v(t) \|. \quad (14)$$

□

#### 4. PROOFS

*Theorem 2*

**Proof.** From (5) we obtain for  $i = i^*$

$$p_{i^*}(t) = p_{i^*}(0) \exp \left( \int_0^t \psi(\tau) d\tau \right), \quad (15)$$

where  $\psi(t) := -\lambda \left( 1 - \frac{\beta_{i^*} e^{-\omega_{i^*}}}{\sum_{j=1}^N p_j \beta_j e^{-\omega_j}} \right)$ . To analyze the evolution of  $p_{i^*}(t)$  we first verify that

$$\begin{aligned} \psi &= \lambda \frac{\beta_{i^*} e^{-\omega_{i^*}} - \sum_{j \in \mathcal{I}_*} p_j \beta_j e^{-\omega_j} - p_{i^*} \beta_{i^*} e^{-\omega_{i^*}}}{\sum_{j=1}^N p_j \beta_j e^{-\omega_j}} \\ &\geq \lambda \frac{(1 - p_{i^*}) \beta_{i^*} e^{-\omega_{i^*}} - \max_{j \in \mathcal{I}_*} (\beta_j e^{-\omega_j}) \sum_{j \in \mathcal{I}_*} p_j}{\kappa} \\ &= \frac{\lambda}{\kappa} (\beta_{i^*} e^{-\omega_{i^*}} - \max_{j \in \mathcal{I}_*} (\beta_j e^{-\omega_j})) (1 - p_{i^*}) \end{aligned}$$

where  $\kappa := \max_{t \geq 0} \sum_{j=1}^N p_j \beta_j e^{-\omega_j}$  is bounded and positive for every  $t \geq 0$ .

Denoting  $\underline{\omega} := \min_{j \in \mathcal{I}_*} \omega_j$  and  $\bar{\beta} := \max_{j \in \mathcal{I}_*} \beta_j$ , applying condition (6), and using the fact that  $\epsilon > c$  we can conclude that there exists  $\delta > 0$  such that

$$\frac{1}{T} \int_t^{t+T} (\underline{\omega} - \omega_{i^*}) d\tau > \ln \bar{\beta} - \ln \beta_{i^*} + \delta$$

and therefore

$$\begin{aligned} \frac{1}{T} \int_t^{t+T} (-\omega_{i^*} + \ln \beta_{i^*}) d\tau - \delta/2 \\ > \frac{1}{T} \int_t^{t+T} (-\underline{\omega} + \ln \bar{\beta}) d\tau + \delta/2. \end{aligned}$$

Because  $\exp(\cdot)$  is a monotonically increasing function, it also follows that

$$\left( \frac{1}{T} \int_t^{t+T} \beta_{i^*} e^{-\omega_{i^*}} d\tau \right) e^{-\delta/2} > \left( \frac{1}{T} \int_t^{t+T} \bar{\beta} e^{-\underline{\omega}} d\tau \right) e^{\delta/2}$$

holds. Therefore, there exists  $\epsilon > 0$  such that

$$\frac{1}{T} \int_t^{t+T} \beta_{i^*} e^{-\omega_{i^*}} d\tau - \frac{1}{T} \int_t^{t+T} \bar{\beta} e^{-\underline{\omega}} d\tau > \epsilon.$$

Combining the previous results we further conclude that

$$\begin{aligned} \frac{1}{T} \int_t^{t+T} \psi(\tau) d\tau &\geq \frac{1}{T} \int_t^{t+T} \lambda \frac{\beta_{i^*} e^{-\omega_{i^*}} - \bar{\beta} e^{-\underline{\omega}}}{\kappa} (1 - p_{i^*}) d\tau \\ &\geq \frac{\lambda \epsilon}{\kappa} (1 - \max_{t \geq 0} p_{i^*}). \end{aligned}$$

Examine now (15). Let  $\bar{t} := t - \bar{n}T \geq 0$ , where  $\bar{n}$  is the largest integer that satisfies  $\bar{n} \leq \frac{t}{T}$ . Then, we obtain

$$\begin{aligned} p_{i^*}(t) &= p_{i^*}(0) \exp \left( \int_0^{\bar{t}} \psi(\tau) d\tau + \int_{\bar{t}}^t \psi(\tau) d\tau \right) \\ &= p_{i^*}(0) \exp \left( \int_0^{\bar{t}} \psi(\tau) d\tau \right. \\ &\quad \left. + \sum_{j=1}^{\bar{n}} \int_{\bar{t}+(j-1)T}^{\bar{t}+jT} \psi(\tau) d\tau \right) \\ &\geq p_{i^*}(0) \exp \left( \int_0^{\bar{t}} \psi(\tau) d\tau \right. \\ &\quad \left. + \bar{n} \left[ \frac{\lambda \epsilon}{\kappa} (1 - \max_{t \geq 0} p_{i^*}(t)) \right] T \right), \quad \forall t \geq 0 \end{aligned}$$

From the definition of  $\bar{n}$  we conclude that  $\bar{n} \geq \frac{t}{T} - 1$  and consequently

$$\begin{aligned} \bar{n} \left[ \frac{\lambda \epsilon}{\kappa} (1 - \max_{t \geq 0} p_{i^*}(t)) \right] T &\geq \left( \frac{t}{T} - 1 \right) \left[ \frac{\lambda \epsilon}{\kappa} (1 - \max_{t \geq 0} p_{i^*}(t)) \right] T \\ &= \left[ \frac{\lambda \epsilon}{\kappa} (1 - \max_{t \geq 0} p_{i^*}(t)) \right] (t - T). \end{aligned}$$

Thus,

$$\begin{aligned} p_{i^*}(t) &\geq p_{i^*}(0) \exp \left( \int_0^{\bar{t}} \psi(\tau) d\tau \right) \\ &\quad \exp \left( \frac{\lambda \epsilon}{\kappa} (1 - \max_{t \geq 0} p_{i^*}(t)) (t - T) \right) \\ &\geq \alpha p_{i^*}(0) \exp \left( \frac{\lambda \epsilon}{\kappa} (1 - \max_{t \geq 0} p_{i^*}(t)) (t - T) \right), \end{aligned}$$

for some  $\alpha > 0$ , where we have used the fact that  $0 \leq \bar{t} < T$  and  $\psi(t)$  is bounded. By contradiction it is now straightforward to conclude that  $p_{i^*} \rightarrow 1$  as  $t \rightarrow \infty$ . □

Theorem 5

**Proof.** [Outline] First, it is shown that if (8) holds and  $P$  remains uniformly bounded, then there exist positive constants  $c_i$ ,  $\lambda_i$ ,  $\gamma_i^w$ ,  $\gamma_i^v$ ,  $\gamma_i^\phi$  such that

$$\begin{aligned} \|\tilde{x}_i(t)\| &\leq c_i e^{-\lambda_i t} \|\tilde{x}_i(0)\| + \gamma_i^w \sup_{\tau \in [0,t)} \|w(\tau)\| \\ &+ \gamma_i^v \sup_{\tau \in [0,t)} \|v(\tau)\| + \gamma_i^\phi \sup_{\tau \in [0,t)} \|\phi_i(t, x(\tau), u(\tau))\| \end{aligned} \quad (16)$$

$\forall t \geq 0$ , where

$$\phi_i(t, x, u) := \Delta A_i x + \Delta B_i u - L_i \Delta C_i x,$$

$L_i := P_i C_i' R_i^{-1}$  is the observer gain, and  $\Delta(\cdot)_i := (\cdot)_i - (\cdot)$  denotes the mismatch between the model used to derive the  $i^{\text{th}}$  local estimator and the true system (1). To prove (9), we use the fact that

$$\tilde{x} = \sum_{i=1}^N p_i \hat{x}_i - \sum_{i=1}^N p_i x = \sum_{i=1}^N p_i \tilde{x}_i. \quad (17)$$

and therefore  $\|\tilde{x}(t)\| \leq N \|\tilde{x}_i(t)\|$ . It is now straightforward to conclude (9) by observing that each  $\tilde{x}_i$  can be viewed as a cascade of two ISS systems: inequality (16) together with

$$\|\dot{\phi}_i\| \leq (\|\Delta A_i\| + \|L_i \Delta C_i\|) \|x\| + \|\Delta B_i\| \|u\|$$

and system (1), which is ISS with respect to the inputs  $u$  and  $w$ . Expressions (10) and (11) can then be easily derived from the results above.  $\square$

Theorem 6

**Proof.** From Theorem 2 and Corollary 3 we conclude (13). From Theorem 2 it also follows that  $p_{i_\theta} \rightarrow 1$  as  $t \rightarrow \infty$ . Thus, from (17),  $\lim_{t \rightarrow \infty} \sup \|\tilde{x}\| = \lim_{t \rightarrow \infty} \sup \|\tilde{x}_{i_\theta}\|$ . Using (16) for  $i = i_\theta$  and noticing that  $\phi_{i_\theta} = 0$  we conclude (14).  $\square$

5. ILLUSTRATIVE EXAMPLE

The CT-MMAE with measuring functions  $\omega_i = \|y - \hat{y}_i\|_{S_i}$  was tested and evaluated using the two-cart mass-spring-damper (MSD) system shown in Fig. 2. The output signal  $y$  is the position of cart  $m_2$  (i.e.,  $x_2$ ) corrupted by measurement noise  $v$ . The disturbance  $w$  only affects  $m_2$ . A state-space representation of the plant, including the disturbances and noise inputs, is given by (1) with

$$A = \begin{bmatrix} 0 & 0 & 1 & 0 & 0 \\ 0 & 0 & 0 & 1 & 0 \\ \frac{-k_1}{m_1} & \frac{k_1}{m_1} & \frac{-b_1}{m_1} & \frac{b_1}{m_1} & 0 \\ \frac{k_1}{m_2} & \frac{-(k_1+k_2)}{m_2} & \frac{b_1}{m_2} & \frac{-(b_1+b_2)}{m_2} & \frac{1}{m_2} \\ 0 & 0 & 0 & 0 & -0.1 \end{bmatrix}, \quad B = \begin{bmatrix} 0 \\ 0 \\ \frac{1}{m_1} \\ 0 \\ 0 \end{bmatrix},$$

$$G' = [0 \ 0 \ 0 \ 0 \ 0 \ 1], \quad C = [0 \ 1 \ 0 \ 0 \ 0],$$

where  $m_1 = m_2 = 1$  Kg;  $k_2 = 0.15$  N/m;  $b_1 = b_2 = 0.1$  Ns/m; and  $k_1$  is an unknown parameter that can assume values in the interval  $[0.25, 1.75]$ . Using the results in Corollary 4 we can infer the corresponding region of attraction of each local observer and from this select a convenient discrete parameter space  $\Theta$ . Figure 3 illustrates the procedure adopted with  $N = 4$  local observers. We divided uniformly the interval where  $k_1$  can leave into 4 sub-intervals and from these we computed the nominal values

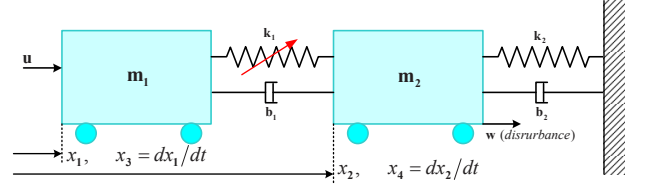

Fig. 2. The two-cart MSD system. The spring-constant  $k_1$  is uncertain.

for  $k_1$  such that the region of attraction of each estimator corresponds to the sub-intervals. We obtained the following set  $\Theta = \{0.35, 0.76, 1.15, 1.53\}$ . The y-axis corresponds to the normalized pseudo-distance  $d(\theta, k_1) = \log \frac{\|\cdot\|_{2,\theta}}{\|\cdot\|_{2,k_1}}$ , where  $\|\cdot\|_{2,\theta} := \|C_\theta(sI - A_\theta)^{-1}B_\theta + D\|_2$ . Figures 4–7 show the time evolutions of some representative signals for deterministic and stochastic noise and disturbance signals and with  $u = 0$ . In the deterministic case,  $v$  and  $w$  are a sum of 10 sinusoidal signals (with different amplitude and frequency). In the stochastic case,  $v$  and  $w$  are white noise signals. To test the robustness to unstructured uncertainty, in all the simulations, the measurements used by the local estimators suffer from a delay of  $\tau = 0.01$  s.

The results show that the true model is always corrected identified even when  $k_1$  is near the boundary between two adjacent regions of attraction. (compare the values of  $k_1$  with the regions in Fig. 3).

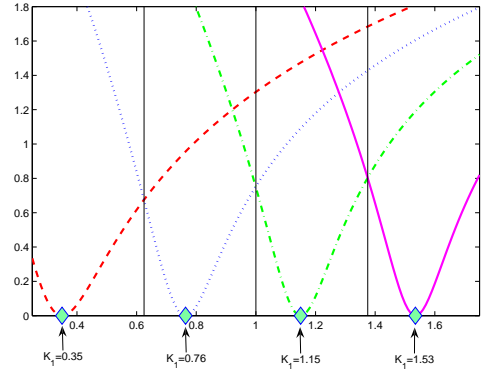

Fig. 3. Nominal values for estimators and their regions of attraction  $\Omega_i$ .

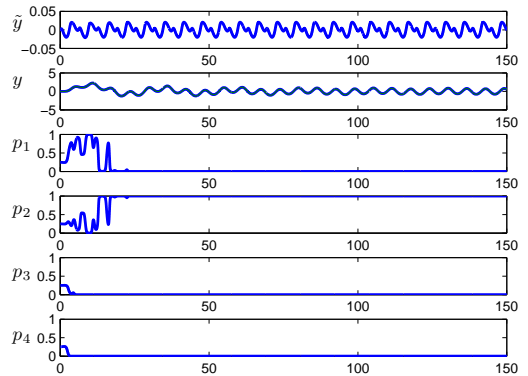

Fig. 4. Deterministic case:  $k_1 = 0.76$ .

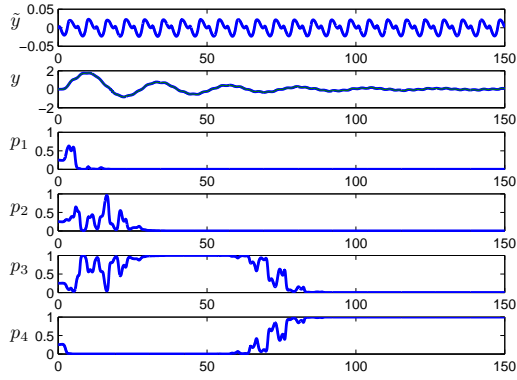

Fig. 5. Deterministic case:  $k_1 = 1.4$ .

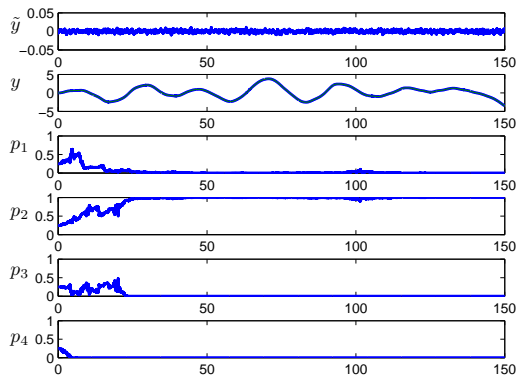

Fig. 6. Stochastic case:  $k_1 = 0.76$ .

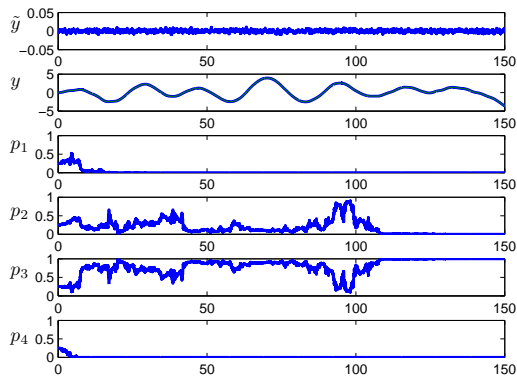

Fig. 7. Stochastic case:  $k_1 = 1.05$ .

## 6. CONCLUSIONS

We presented and analyzed a class of CT-MMAE system for state-affine MIMO systems with parametric uncertainty. We showed that if some suitable persistent of excitation like conditions hold, the model identified is the one that exhibits less output error “power”. We derived a distance like metric between the true plant and the identified model and also provided conditions for convergence of the state estimation error and for  $\mathcal{L}_2$  and  $\mathcal{L}_\infty$  stability.

## REFERENCES

- A. P. Aguiar, M. Athans, and A. Pascoal. Convergence properties of a continuous-time multiple-model adaptive estimator. In *Proc. of ECC'07 - European Control Conference*, Kos, Greece, July 2007a.
- A. Pedro Aguiar, V. Hassani, A. Pascoal, and M. Athans. Identification and convergence analysis of a class of continuous-time multiple-model adaptive estimators. Technical report, Institute for Systems and Robotics, Lisbon, Portugal, December 2007b.
- B. D. O. Anderson and J. B. Moore. *Optimal Filtering*. Prentice-Hall, New Jersey, USA, 1979.
- B. D. O. Anderson, T. S. Brinsmead, F. De Bruyne, J. Hespanha, D. Liberzon, and A. S. Morse. Multiple model adaptive control: Part I: Finite controller coverings. *Int. J. of Robust and Nonlinear Control*, 10:909–929, 2000.
- M. Athans, D. Castanon, K-P. Dunn, C. S. Greene, W. H. Lee, N. R. Sandell, and A. S. Willsky. The stochastic control of the F-8c aircraft using a multiple model adaptive control (mmac) methodpart i: Equilibrium flight. *IEEE Trans. on Automat. Contr.*, 22:768–780, 1977.
- M. Athans, D. Castanon, K-P. Dunn, C.S. Greene, W. H. Lee, N. R. Sandell, and A. S. Willsky. Investigation of the multiple method adaptive control (MMAC) method for flight control systems. Technical Report NASA-CR-2916, NASA Technical Reports, 1979.
- M. Athans, S. Fekri, and A. Pascoal. Issues on robust adaptive feedback control. In *Preprints 16th IFAC World Congress, Invited Plenary paper*, pages 9–39, Prague, Czech Republic, July 2005.
- K-P. Dunn. *Measure Transformation, Estimation, Detection and Stochastic Control*. PhD thesis, Washington University, St. Louis, MO, USA, 1974.
- K-P. Dunn and I. B. Rhodes. A generalized representation theorem with applications to estimation and hypothesis testing. In *11th Annual Allerton Conf. on Circuit and System Theory*, 1973.
- S. Fekri, M. Athans, and A. Pascoal. Issues, progress and new results in robust adaptive control. *Int. J. of Adaptive Control and Signal Processing*, 20:519–579, 2006.
- S. Fekri, M. Athans, and A. Pascoal. Robust multiple-model adaptive control (RMMAC): A case study. *Int. J. of Adaptive Control and Signal Processing*, 21:1–30, 2007.
- R. J. Fitzgerald. Divergence of the kalman filter. *IEEE Trans. on Automat. Contr.*, 16:736–747, 1971.
- J. Hespanha, D. Liberzon, A. S. Morse, B. D. O. Anderson, T. S. Brinsmead, and F. De Bruyne. Multiple model adaptive control: Part II: Switching. *Int. J. of Robust and Nonlinear Control*, 11: 479–496, 2001.
- A. Krener. Kalman-Bucy and minimax filtering. *IEEE Trans. on Automat. Contr.*, 25:291–292, 1980.
- D. G. Lainiotis. Partitioning: A unifying framework for adaptive systems I: Estimation II: Control. *IEEE Trans. on Automat. Contr.*, 64:1182–1198, 1976.
- X. R. Li and Y. Bar-Shalom. Multiple-model estimation with variable structure. *IEEE Trans. on Automat. Contr.*, 41:478–493, 1996.
- D. T. Magill. Optimal adaptive estimation of sampled stochastic processes. *IEEE Trans. on Automat. Contr.*, 10:434–439, 1965.
- A. S. Morse. Supervisory control of families of linear set-point controllers-part I: Exact matching. *IEEE Trans. on Automat. Contr.*, 41:1413–1431, 1996.
- A. S. Morse. Supervisory control of families of linear set-point controllers-part II: Robustness. *IEEE Trans. on Automat. Contr.*, 42:1500–1515, 1997.
- K. S. Narendra and J. Balakrishnan. Adaptive control using multiple models. *IEEE Trans. on Automat. Contr.*, 42:171–187, 1997.
- K. S. Narendra and O. A. Driollet. Stochastic adaptive control using multiple models for improved performance in the presence of random disturbances. *Int. J. Adapt. Control Signal Process.*, 15:287–317, 2001.
- C. F. Price. An analysis of the divergence problem in the kalman filter. *IEEE Trans. on Automat. Contr.*, 13:699–702, 1968.
- G. J. Schiller and P. S. Maybeck. Control of a large space structure using MMAE/MMAC techniques. *IEEE Transactions on Aerospace and Electronic System*, 33:1122–1131, 1997.